

MODEL: SL0277
ASSEMBLY INSTRUCTIONS
READ AND SAVE THESE INSTRUCTIONS

READ INSTRUCTIONS ALL THE WAY THROUGH PRIOR TO ASSEMBLY.
MAKE SURE ALL PARTS ARE FIRMLY TIGHTENED.

UNPACK THE FOUNTAIN

YOU SHOULD HAVE RECEIVED THE FOLLOWING PARTS: UPPER FTN BODY, RESERVOIR, BASE, PUMP, LED LIGHT, SOLAR PANEL, BRACKET, TUBE, SPIKE. TO PROTECT THE FINISH, PLACE ALL PARTS ON A SOFT SURFACE.

FOUNTAIN ASSEMBLY

1. PLACE LOWER RESERVOIR ON TOP OF BASE AND TWIST THE LOWER RESERVOIR CLOCKWISE TO SECURE.

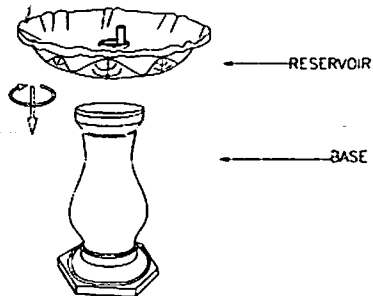

2. FEED THE PUMP POWER CORD THROUGH THE PLASTIC TUBE TOWARD BOTTOM OF BASE. CORD EXIT OUT FROM CHANNEL ON THE BOTTOM OF THE BASE.

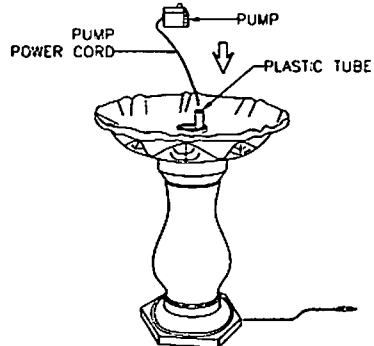

3. ATTACH PUMP TO RUBBER HOSE, THEN PLACE THE UPPER FOUNTAIN BODY INTO RESERVOIR AND TWIST THE UPPER FOUNTAIN BODY CLOCKWISE TO SECURE.

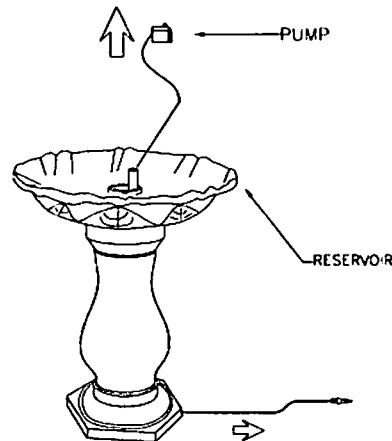
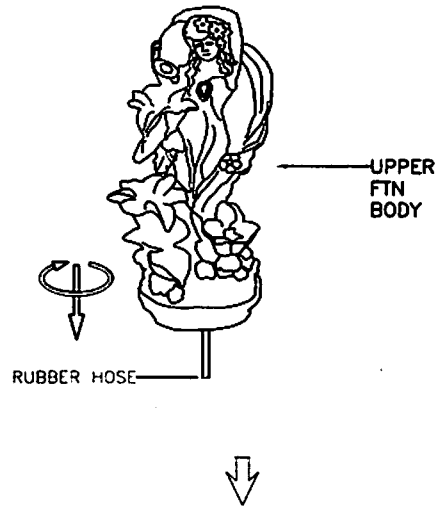

MODEL: SL0277
ASSEMBLY INSTRUCTIONS
READ AND SAVE THESE INSTRUCTIONS

FOUNTAIN ASSEMBLY

4. FILL RESERVOIR WITH APPROPRIATE AMOUNT OF WATER TO COMPLETELY SUBMERSE THE PUMP.

NOTE: DISTILLED WATER IS RECOMMENDED TO REDUCE MINERAL DEPOSITS AND BACTERIA BUILD-UP.



NOTE: THE SOLAR PANEL CAN BE MOUNTED USING SPIKE OR JUST BE PLACED ON GROUND.

5. JOIN BRACKET, TUBE AND SPIKE TOGETHER, THEN ATTACH BRACKET TO BACK OF THE SOLAR PANEL AS SHOWN.

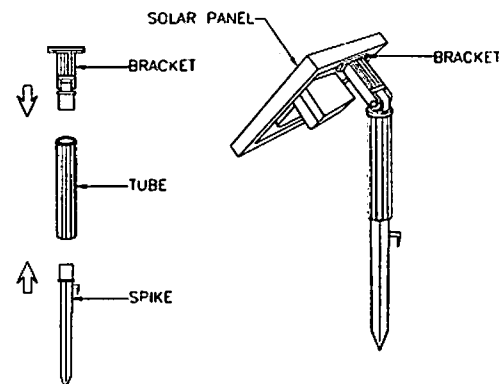

6. TWIST PUMP AND LED LIGHT PLUGS SLIGHTLY AND PUSHING IT INTO THE HOLE FOR PUMP AND LED LIGHT PLUGS. MAKE SURE THE SEALING RINGS ARE FULLY IN GROOVES.

7. INSERT SPIKE INTO GROUND, MAKE SURE THE SOLAR PANEL CAN RECEIVE DIRECT SUNSHINE, NOT BE SHADED.

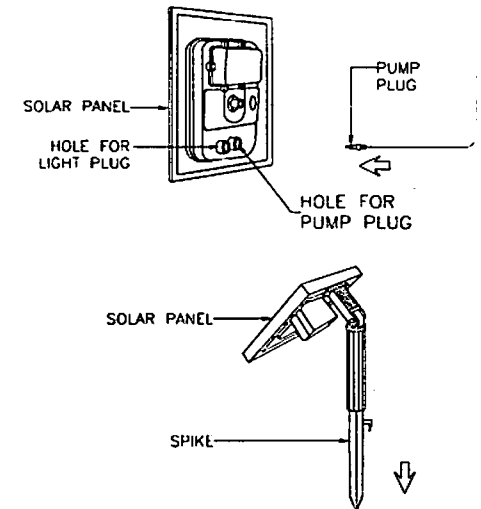

MODEL: SL0277

ASSEMBLY INSTRUCTIONS

READ AND SAVE THESE INSTRUCTIONS

FOUNTAIN ASSEMBLY

8. YOUR NEW FOUNTAIN WILL BEGIN TO WORK WHEN SOLAR PANEL RECEIVE GOOD SUNSHINE; OR PRESS "ON" BUTTON TO RUN YOUR FOUNTAIN BY BATTERY IN A CLOUDY DAY OR AT NIGHT.

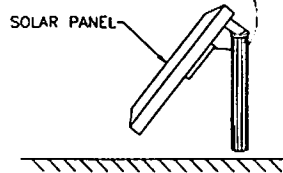
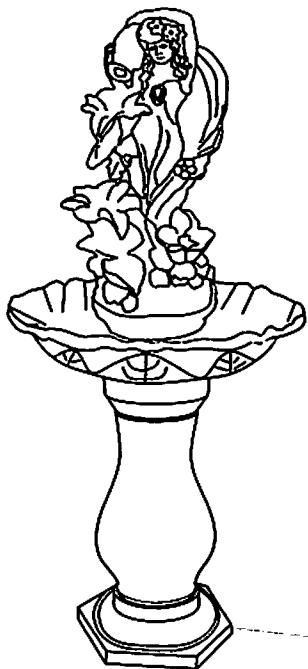

SOLAR PUMP FUNCTIONS:

1. THIS PUMP IS DESIGNED TO RUN FROM DIRECT SUNSHINE DURING DAY, WHEN SUN GOES DOWN THE PUMP WILL TURN OFF. IF YOU WANT TO RUN PUMP AT NIGHT, THEN PRESS ON BUTTON TO ENJOY THE FOUNTAIN UNTIL IT RUNS OUT OF CHARGE.

2. THE LED LIGHTS ONLY WORK AT NIGHT WHEN THE PUMP IS TURNED ON.

3. PUMP RUNS BY SOLAR PANEL DURING DAY, IN THE MEANTIME, PART OF SOLAR PANEL POWER WILL CHARGE BATTERIES. IF YOU WANT TO HAVE PUMP RUN LONGER TIME AT NIGHT, JUST TURN OFF THE PUMP DURING DAY, LET ALL POWER GO FOR BATTERIES.

4. THE INDICATOR (BESIDE ON/OFF BUTTON) WILL BE GREEN LIGHT ON WHEN PUMP WORKS NORMALLY; RED LIGHT ON WHEN BATTERY LOW.

5. ALTHOUGH THERE MAY BE SOME INITIAL CHARGE IN BATTERY, WE RECOMMEND FULLY CHARGING IT BEFORE FIRST USE. TURN OFF THE PUMP AND LEAVE THE SOLAR PANEL IN GOOD SUNLIGHT FOR 6 HOURS TO ENSURE THE BATTERY PACK IS FULL CHARGED.

TROUBLE SHOOTING:

1. IF YOUR FOUNTAIN DOES NOT WORK, CHECK SOLAR PANEL IS IN CORRECT POSITION, RECEIVING DIRECT SUNLIGHT AND NOT IN SHADOW.

2. IF YOU FIND INDICATOR RED LIGHT ON, PUMP IS NOT WORKING. THAT MEANS BATTERY LOW. PLEASE LEAVE SOLAR PANEL IN GOOD SUNSHINE TO CHARGE THE BATTERY.

3. CHECK CONNECTIONS BETWEEN THE PUMP/LED AND THE SOLAR PANEL.

4. CHECK WATER LEVEL AND MAKE SURE THE PUMP IS SUBMERGED.

5. CHECK IF PUMP IMPELLER IS BLOCKED BY DEBRIS.

IMPORTANT PUMP INFORMATION:

PUMP MUST BE FULLY SUBMERSED IN WATER WHILE OPERATING.

WARNING:

* ONCE A WEEK INSPECT FOUNTAIN, FLOOR AND ADJACENT WALL FOR MOISTURE BUILD-UP AND CLEAN AS NECESSARY. THIS IS ESPECIALLY IMPORTANT FOR HUMID ENVIRONMENTS.

** THIS FOUNTAIN IS RATED FOR OUTDOOR USE.

*** MOVE YOUR FOUNTAIN INTO YOUR ROOM IN FREEZING DAYS TO PROTECT THE FOUNTAIN.

**** IF YOU DO NOT USE THIS FOUNTAIN FOR LONG TIME, PLEASE UNPLUG THE PUMP AND LED LIGHT PLUGS FROM BOTTOM OF SOLAR PANEL.

PLEASE SEE NEXT PAGE FOR BATTERY PACK REPLACEMENT.

MODEL: SL0277

ASSEMBLY INSTRUCTIONS

READ AND SAVE THESE INSTRUCTIONS

BATTERY PACK INFORMATION:

* RECHARGABLE BATTERY PACK BECOME LESS EFFICIENT WITH REPEATED CHARGE AND DISCHARGE CYCLES, THE CAPACITY OF THE BATTERY PACK MAY REDUCE OVER TIME. IF YOU FIND THAT THE BATTERY PACK APPEAR LESS EFFICIENT, TRY TO BOOST CHARGE IT. TO DO THIS, LEAVE OFF THIS SOLAR PANEL FOR 2~3 DAYS IN SUNNY DAYS TO ALLOW THE MAXIMUM CHARGE TO THE BATTERY PACK. WE RECOMMEND THAT YOU DO THIS OCCASIONALLY TO HELP PROLONG THE LIFE OF BATTERY PACK. IF YOUR BATTERY PACK STILL DOES NOT WORK WELL AFTER THIS BOOST CHARGE, YOU SHOULD REPLACE THE BATTERY PACK AS BELOW.

** AFTER THE BATTERY PACK USED FOR 12~18 MONTHS, IT MAY HAVE REACHED IT'S SERVICE LIFE, YOU SHOULD REPLACE THE BATTERY PACK.

BATTERY PACK REPLACEMENT INSTRUCTIONS:

1. PULL OUT THE SPIKE AND REMOVE BRACKET FROM BACK OF SOLAR PANEL.

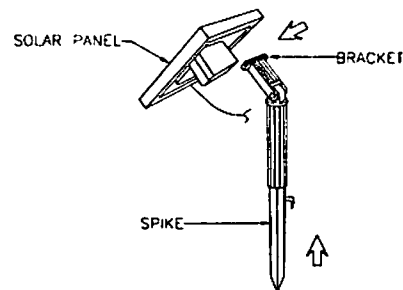

2. REMOVE PUMP PLUG FROM SOLAR PANEL AS SHOWN.

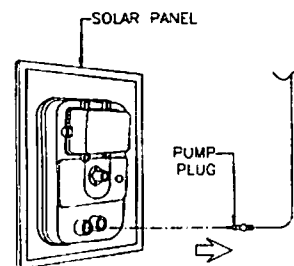

3. REMOVE COVER FROM SOLAR PANEL BY UNSCREWING (6) SCREWS.

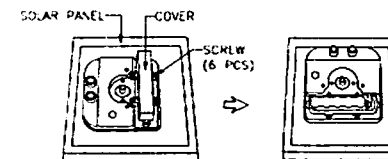

4. DISCONNECT THE CONNECTORS, THEN REPLACE THE OLD BATTERY PACK WITH A NEW BATTERY PACK AND JOIN THE CONNECTORS TOGETHER.

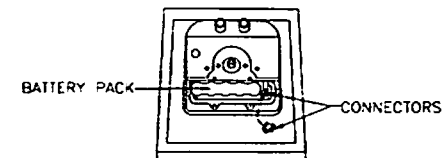

5. SECURE THE COVER TO SOLAR PANEL WITH THE (6) SCREWS REMOVED ABOVE.

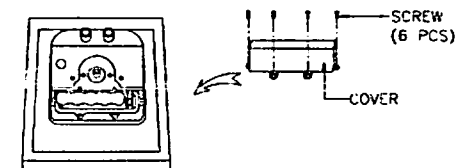

6. TWIST PUMP/LED PLUGS SLIGHTLY AND PUSHING IT INTO THE HOLE FOR PUMP/LED PLUGS, MAKE SURE THE SEALING RINGS ARE FULLY IN GROOVES.

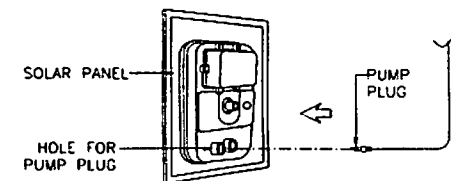

7. ATTACH BRACKET TO BACK OF THE SOLAR PANEL AND INSERT SPIKE INTO GROUND.

