



Thank you for choosing Sunnydaze Decor. We stand behind our brand and the quality of the items we sell. Replacement parts or products will be sent at our discretion, within the one-year warranty period. Proof of purchase, with the date of purchase as well as photos of the defective merchandise, must be provided.





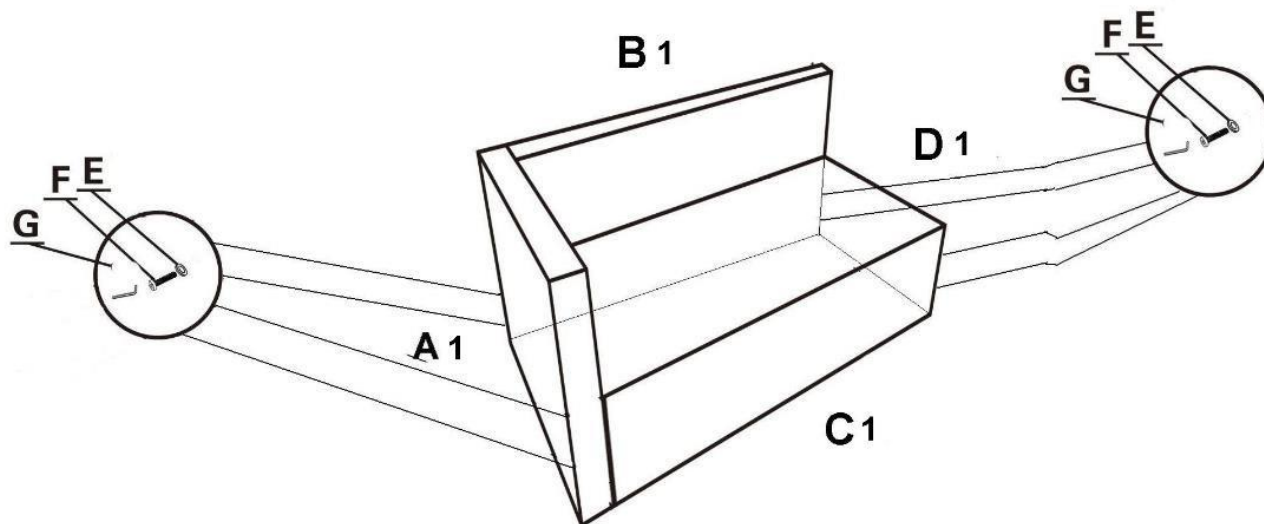

If you have any questions, comments or concerns please feel free to contact us by phone at: **888-881-4668**. You may also contact us by email: customerservice@serenityhealth.com, or via our webpage at: www.serenityhealth.com/contact-us/

1162



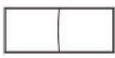

ASSEMBLY:

A1		1PC	B1		1PC	C 1		1PC
D1		1PC	E		12PCS	F		12PCS
G		1PC						

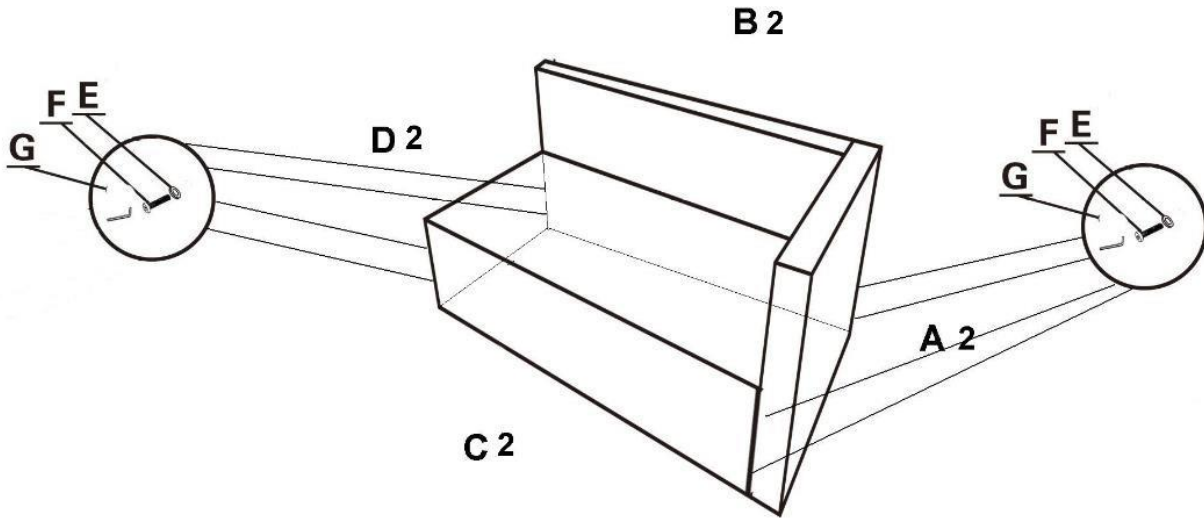

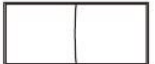



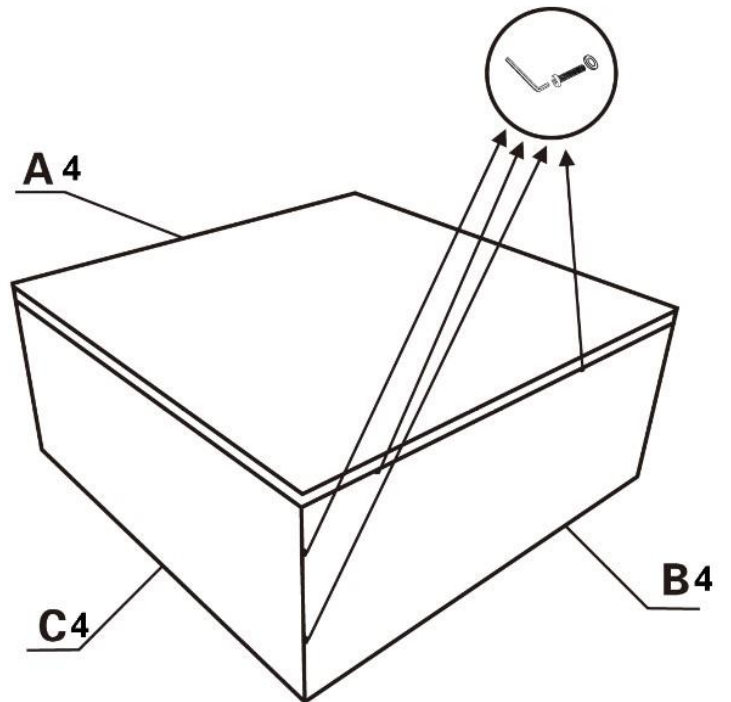

A2		1PC	B2		1PC	C2		1PC
D2		1PC	E		11PCS	F		11PCS
G		1PC						

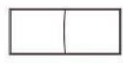

A4		1PC
B4		2PC
C4		2PC
D		12PCS
E		12PCS
F		1PC



A3		1PC	B3		1PC	C3		1PC
D3		1PC	E		12PCS	F		12PCS
G		1PC						

